

# RIYA

Rounded shapes, flowing lines, intuitive controls – RIYA is the polar opposite of the usual technoid swivel chair look. It stimulates the user's concentration and inspiration and symbolises an open and humane office culture. A swivel chair with a human touch

for all modern office spaces and places. Its intuitive technology is discreet and reveals itself during use. The control elements make sense on a tactile as well as visual level, and are easy to operate. Adaptability is one of its great strengths.

**Design: Pearson Lloyd**



**bene**

**INSPIRING OFFICES. SINCE 1790.**

## PRODUCT DESCRIPTION

- ❶ **Seat upholstery:** Ergonomically shaped seat upholstery made of polyurethane cold foam. Adjustable seat height and depth. Optionally available with flame-resistant foam.
- ❷ **Backrest:** Available in a high or medium-high version with mesh or upholstery.  
 Mesh: Circumferential frame (polypropylene) with functional polyester fabric.  
 Upholstery: Polypropylene back tray with ergonomically shaped upholstered back made of polyurethane cold foam.
- ❸ **Frame:** Swivel base, 5-star, made of plastic or aluminium. Comes standard with hard castors for soft floors and soft castors for hard floors. Plastic or felt glides are also available for the aluminium frame.
- ❹ **Armrests:** 2D armrests/3D armrests: Polyamide plastic with padding in SZ black. Optionally available without armrests.



The swivel chair features automatic weight regulation; it is also available with synchro-mechanism and seat tilt adjustment.

Colours of the plastic elements: Backrest, armrests and mechanism in off-white or dark grey. Control elements in stone or orange.

## OVERVIEW AND DIMENSIONS

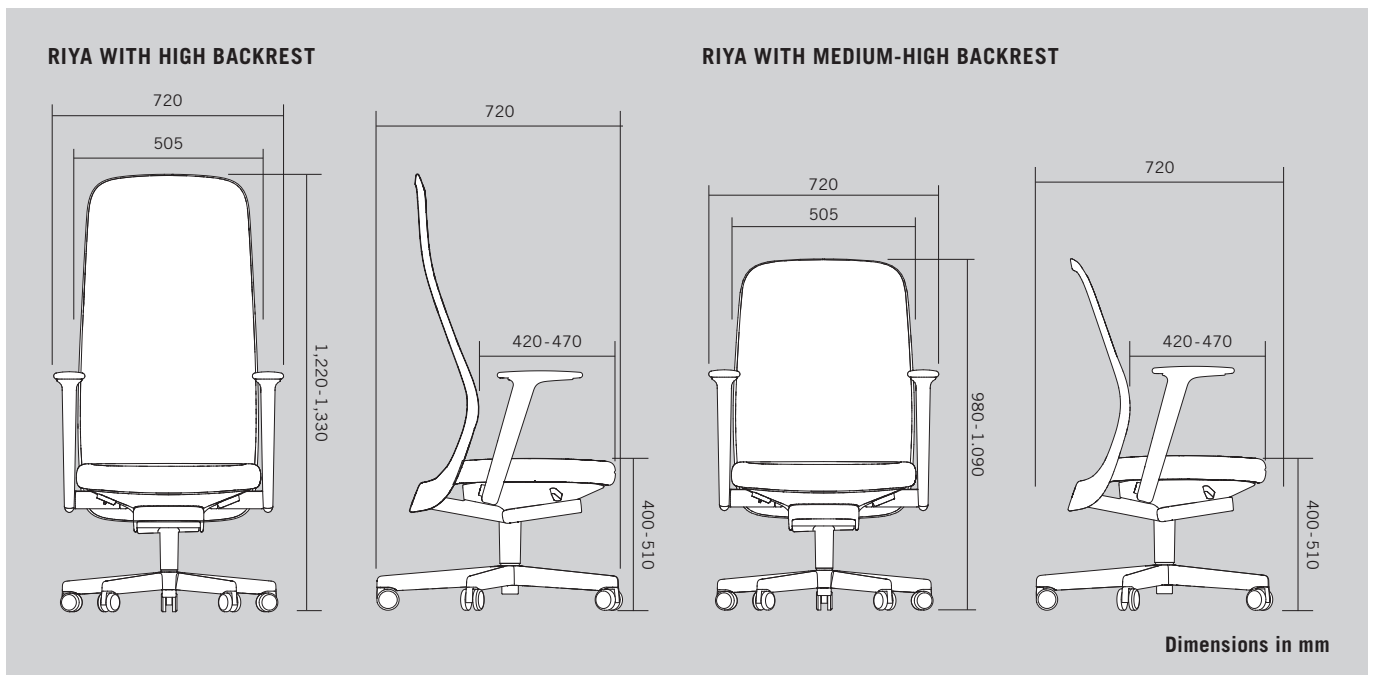

## OPTIONS

### HEADREST



Available with a high back. Made of polyurethane cold foam, with fabric or leather covering. Optionally designed to match the backrest or seat upholstery; with a mesh back, automatically like the seat upholstery.

### LUMBAR SUPPORT



The height of the lumbar support can be adjusted to give your back additional support in the lumbar region without putting any perceptible pressure on it. The support consists of an ergonomically shaped pad made of plastic in off-white or dark grey.

Adjustment range: 45 mm.

## FUNCTION



### Adjusting the seat height

The desired seat height is adjusted by pressing the button on the front right. Seat height can be adjusted from 400 - 510 mm.



### Seat depth adjustment

With the button at the right back the seat depth can be increased up to 50 mm. From 420 to 470 mm.



### Locking the backrest

#### • Automatic weight adjustment:

The backrest can be locked by operating the lever on the front left (middle or rear catch position). To move the seat and backrest in sync, move the lever into the front catch position and lean against the backrest.

#### • Synchronous mechanism incl. seat tilt adjustment:

When the backrest is tilted at the desired angle, the synchronous movement of the seat and backrest can be locked in one of four positions by using the lever on the front left (rear catch position). To release the lock, move the lever to the middle catch position and lean against the backrest.



### Seat tilt adjustment

Only with synchronous mechanism. By moving the lever on the rear left (front catch position) and leaning on the backrest, the angle of the seat can be tilted forward 3 degrees. To deactivate the seat tilt, lean on the backrest and move the lever to the middle catch position.



### Armrests

• **2D armrests:** Adjustable in height and width. Adjustment range: Height 100 mm/width 60 mm.

• **3D armrests:** Adjustable in height, width and depth. Adjustment range: Height 100 mm/width 60 mm/depth 40 mm.



### Backrest resistance

Adjustment range: 45 - 120 kg body weight.

#### • Automatic weight adjustment:

With automatic weight adjustment, the backrest resistance automatically adjusts to the user's body weight.

#### • Synchronous mechanism:

By turning the wheel at the front left, the amount of pressure of the backrest can be adjusted to fit the body weight and the user's individual impression of what is most comfortable.

## COLOURS & MATERIALS

### METAL SURFACE POWDER-COATED

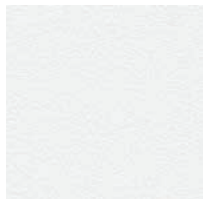

off-white

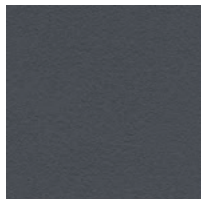

dark grey

### ALUMINIUM NATURAL

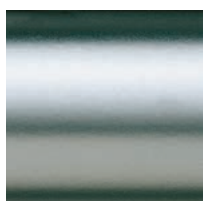

AP alu. polished

### SOLID-COLOURED PLASTIC

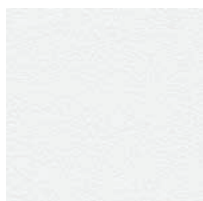

GW off-white

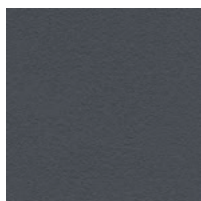

GB dark grey

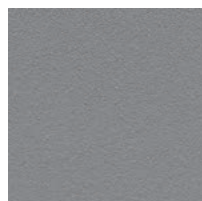

stone



orange

### FABRIC AND LEATHER



Various fabric collections are available for the cover: Era, Urban Plus, Xtreme Plus, Rondo, Step, Step Melange, Remix, Europost, Mainline Flax, Fox, Fiord, Steelcut, Hallingdal, Steelcut Trio, Divina Melange, Divina MD, Omega.

Various leather collections: Entrée, Entrée Color, Superior.

More information about the specific fabric and leather collections is available at [www.bene.com](http://www.bene.com).

