

# SETTLE

## SPACE FOR ENCOUNTER

Settle down, get comfy, and engage with colleagues. With its soft shapes and high quality materials, Bene's upholstered furniture range brings a homely feel to the office. SETTLE consists of individual furniture elements as well as optional modular components that can be combined to create a wide variety of different settings. An optional high backrest can be added to provide additional screening and to incor-

porate a work ledge to create a dynamic room setup. Integrated plug boards enable access to the network and power, allowing for media-supported collaboration. SETTLE can be used in a variety of zones and areas in modern office layouts and works perfectly in combination with other existing Bene product ranges, such as NOOXS, TIMBA, and PARCS.

**Design: Pearson Lloyd**



**bene**

**INSPIRING OFFICES. SINCE 1790.**

## PRODUCT DESCRIPTION

- ❶ **Back panel:** The substructure is made of plywood.
- ❷ **Back Panel Connection Plate**
- ❸ **Cushions:** For backrest 600x360 mm or 450x360 mm (with side armrest).
- ❹ **Frame:** Powder-coated steel, dark grey with plastic glides
- ❺ **Bench:** widths 1.200, 1.500 or 1.800 mm, depth 720 mm, seat depth 495 mm.

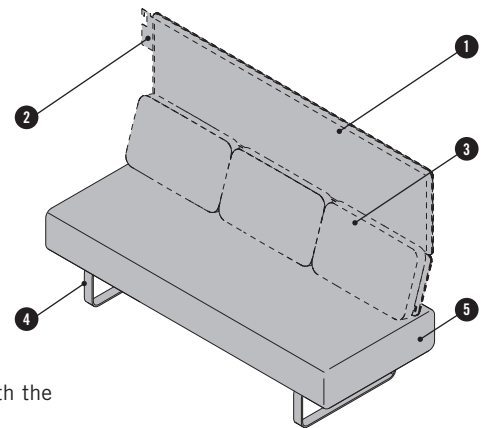

Covers are available in the fabric groups P0 - P4 & leather groups L1 - L2 in accordance with the Bene seating furniture collection.

Colour configuration options: single-coloured, different colour for recessed elements or different colour for recessed elements and back panel. All upholstered elements contain dimensionally stable polyurethane foam padding. Optionally in flame-resistant version according to BS 5852 Part 2, Ignition Source 5 (Crib 5). Sofa, SETTLE 45° and 90° can only be used as a connection element between 2 linear elements and not as an end piece.

## OVERVIEW & DIMENSIONS

<p><b>SOFA, SETTLE, 2-SEATER WITHOUT BACKREST</b></p> <p>* Weight: ~35,5 kg</p>	<p><b>SOFA, SETTLE, 2-SEATER LOW</b></p> <p>~47 kg</p>	<p><b>SOFA, SETTLE, 2-SEATER HIGH</b></p> <p>~61,5 kg</p>	
<p><b>SOFA, SETTLE, 3-SEATER WITHOUT BACKREST</b></p> <p>* Weight: ~45 kg</p>	<p><b>SOFA, SETTLE, 3-SEATER LOW</b></p> <p>~58,5 kg</p>	<p><b>SOFA, SETTLE, 3-SEATER HIGH</b></p> <p>~78,5 kg</p>	
<p><b>SOFA, SETTLE, 45° LOW</b></p> <p>* Weight: ~26 kg</p>	<p><b>SOFA, SETTLE, 45° HIGH</b></p> <p>~36 kg</p>	<p><b>SOFA, SETTLE, 90° LOW</b></p> <p>~40,5 kg</p>	<p><b>SOFA, SETTLE, 90° HIGH</b></p> <p>~58,5 kg</p>
<p><b>SOFA, SETTLE, 2-SEATER INDENTED BACKREST</b></p> <p>* Weight: ~49,5 kg</p>	<p><b>SOFA, SETTLE, 3-SEATER SIDE ARMRESTS</b></p> <p>~63 kg</p>	<p><b>SOFA, SETTLE, 3-SEATER SIDE ARMRESTS</b></p> <p>~63 kg</p>	<p><b>Dimensions in mm</b> * Weight without packing.</p>

## OPTIONS

### WORK LEDGE

Rectangular chipboard surface (19 mm) with skid frame. Ledge surface available in widths of 900 (2-seater) or 1.500 mm (3-seater).

Table top depth: 300 mm and table top height: 1.065 mm. Ledge available in melamine or veneer finish.

Frame: Powder-coated steel, dark grey with plastic glides

Weight: ~14,5 - 17 kg depending on size (weight without packing)

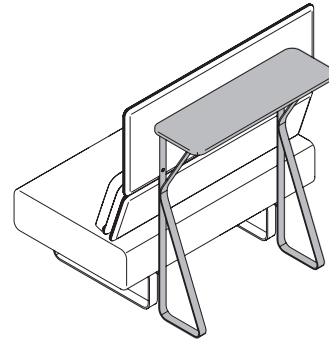

---

### PILLOW ROLL

Measurements: Width: 200 mm, depth: 425 mm and height: 200 mm.

Covers are available in the fabric groups PO - P4 & leather groups L1 - L2 in accordance with the Bene seating furniture collection.

Weight: ~0,36 kg (weight without packing)

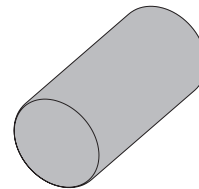

---

### POWER BOX

Available with either 4x Power sockets or 3x power sockets with 2x RJ45-CAT6.

Starter Cable: 5.000 mm

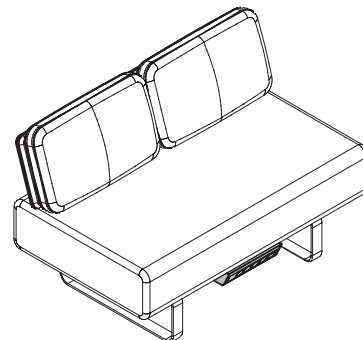

## INSPIRATIONS



Inspiration #01

For waiting areas, break-out areas, cafés or communication zones in the office. SETTLE in a generous 45° application.

---



Inspiration #02

An upholstered furniture setting that requires minimal space, e.g. in a modern management office or in small reception areas.

## INSPIRATIONS



### Inspiration #03

SETTLE creates an optimal environment for free thinking and creative work when used in combination with interactive walls.

---



### Inspiration #04

Soft shapes, materials and colours: SETTLE for cafés.

## INSPIRATIONS



Inspiration #05

SETTLE with a high backrest for visual and acoustic screening.

---



Inspiration #06

Settling in, feeling good and getting comfortable with each other: a screened area for interaction.

## INSPIRATIONS



Inspiration #07

SETTLE for visual and acoustic screening for informal exchanges.

## COLOURS & MATERIALS



All fabric collections are available as reference material: Era, Xtreme Plus, Rondo, Remix, Europost, Mainline Flax, Steelcut, Stamskin Top, Fox, Fiord, Hallingdal, Steelcut Trio, Divina Melange, Divina MD. More information about the specific fabric collections is available at [www.bene.com](http://www.bene.com).

---

### LEATHER: Entrée

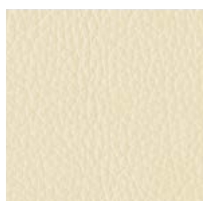

L1 Ivory

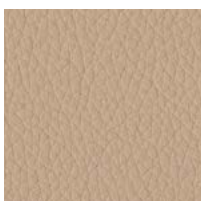

L1 Nature

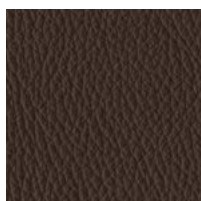

L1 Coffee

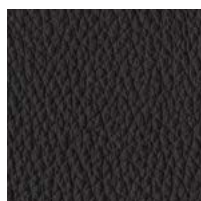

L1 Black

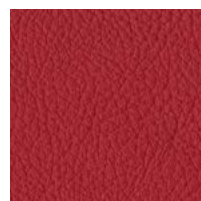

L1 Carmine

### LEATHER: Entrée Color



L2 Olive

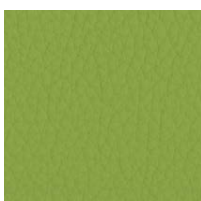

L2 Kiwi

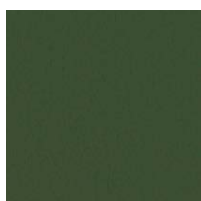

L2 Moss

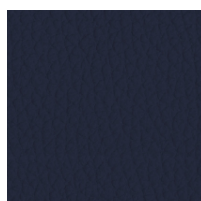

L2 Cobalt

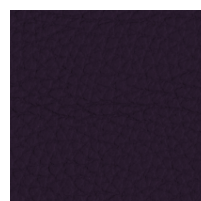

L2 Cassis

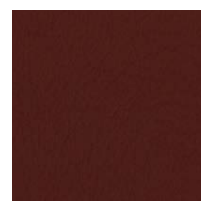

L2 Bordeaux

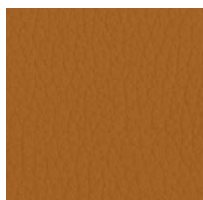

L2 Orange

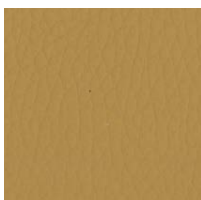

L2 Safran

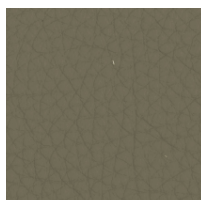

L2 Taupe

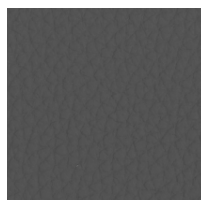

L2 Concrete



L2 Elephant



L2 Alpine



## COLOURS & MATERIALS

### DESK EXTENSION

#### MELAMINE: Basic colours

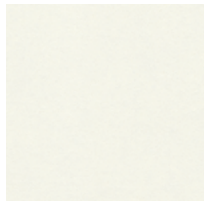

MW white

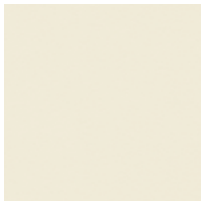

MQ office white

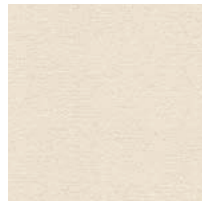

MC canvas<sup>3</sup>

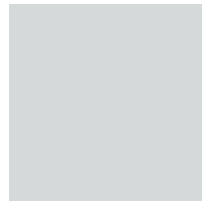

MP platinum<sup>2,3</sup>



TM mud



MH stone grey



MA aluminium<sup>3</sup>



MS slate<sup>3</sup>

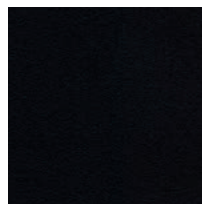

MB basalt



MD urban grey

#### MELAMINE: Additional basic colours<sup>1,2,3</sup>

#### MELAMINE: Decor colours<sup>1,2,3</sup>

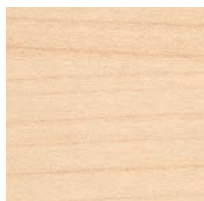

AR maple

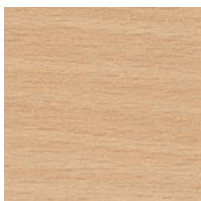

BH beech light

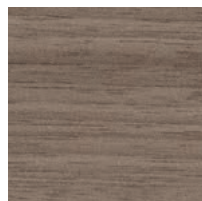

NG walnut grey



EZ oak vicenza

#### MELAMINE: Decor colours, wooden structure<sup>1,2,3</sup>



CE elm white



CO coco

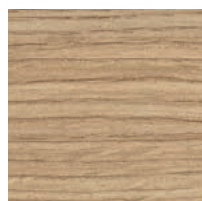

EA oak aragon

#### MELAMINE: Accent colours<sup>1,2,3</sup>

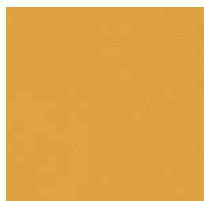

TX mustard



TH marino blue



TS fern green

<sup>1</sup> not available for compact desk top

<sup>2</sup> not available for duo-edge

<sup>3</sup> not available for 3 mm edge, single colour

## COLOURS & MATERIALS

### VENEER: Maple



AK canadian maple

### VENEER: Beech



BG beech grey



BU beech nature

### VENEER: Chestnut



KD chestnut natural



KP chestnut brown



KP chestnut grey

### VENEER: Oak

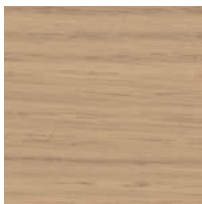

EY oak sylt

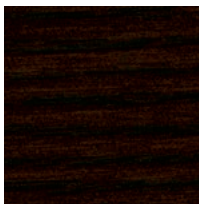

ER oak amaretto

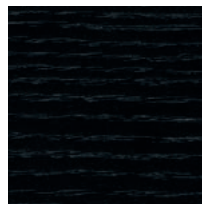

EV oak volcano

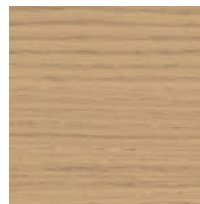

EF oak nature



EG oak grey

### VENEER: Walnut



NF american walnut



NR walnut siena



NB walnut umbra

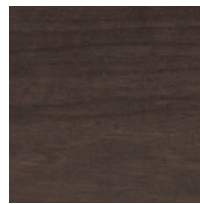

NA wal. anthracite

### VENEER: Bamboo



BJ bamboo

<sup>1</sup> not available for compact desk top

<sup>2</sup> not available for duo-edge

<sup>3</sup> not available for 3 mm edge, single colour

## BENE WORKS SUSTAINABLY

Bene plays a leading role in responsible environmental management. It is practised throughout all company divisions – from product development, procurement, production and logistics to product recycling. Bene considers ecology to be a central element of its responsible and sustainable corporate strategy. Bene sees the legal regulations as minimum requirements and strives for better and more sustainable environmental protection throughout the group. The Bene principle in environmental policy is: **Avoidance – Minimisation – Recycling – Disposal.**

### SETTLE - ECOLOGICAL STANDARDS

- 99.5% recyclable
- 53.4% renewable raw materials
- 23.98% use of recycled product materials (12.53% post-consumer, 11.45%, pre-consumer)
- 18.26% use of recycled product materials that comply with LEED (12.53% post-consumer, 11.45%, pre-consumer)
- Resource-conserving product design
- Use of certified wood (chain of custody)
- Use of materials tested for presence of hazardous substances
- No PVC, chromium, lead or mercury used
- Individual parts can be sorted according to homogeneous categories
- Recyclable, with a positive contribution to the carbon footprint (average 245.2 kg CO<sub>2</sub>)

## SETTLE LEED POINTS

Leadership in Energy and Environmental Design (LEED) is a system developed by the U.S. Green Building Council to classify ecological construction. As an internationally recognised standard, LEED sets out numerous guidelines for environmentally friendly, resource-efficient, and sustainable construction. The use of SETTLE is an important contribution to LEED certification. The following criteria for this are from “LEED 2009 for Commercial Interiors”:

MR Credit 4	Recycling share	up to 2 points
MR Credit 5	Regional materials	up to 2 points
MR Credit 7	Certified wood	up to 1 point
IEQ Credit 4.5	Material with low hazardous substance content	up to 1 point

### SETTLE MATERIAL COMPONENTS

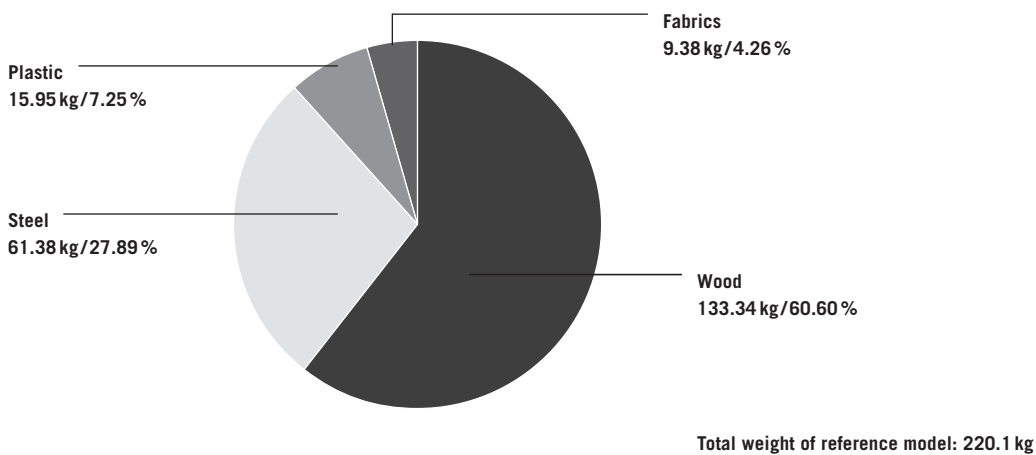

Environment-related information about Bene: [www.bene.com / sustainability](http://www.bene.com/sustainability)